

FERRAO & FERRÃO LDA

TABELA N° 15



FERMAV
Drainage System

**AUTOCLISMOS
VÁLVULAS DE DUCHE
BASES E CABINES**

OLI

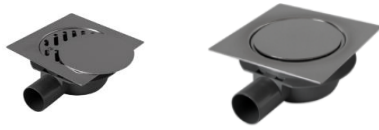

BASE COM FIXAÇÃO CENTRAL

Código	Embalagem	Medidas	und
2050115153	5	15 x 15	30,50 €
2050120203	5	20 x 20	33,55 €



BASE 15X15 P/ AZULEJO INOX ESCOVADO

Código	Embalagem	Medidas	und
205011515A	6	15x15	61,76 €



BASE LINEAR PREFURADA 360° INOX

Código	Medida caixa	Grelha	und
20501IP300	380 x 155 x 90	300 mm	75,65 €
20501IP500	580 x 155 x 90	500 mm	93,82 €
20501IP600	680 x 155 x 90	600 mm	99,86 €
20501IP800	880 x 155 x 90	800 mm	112,41 €
20501IP900	980 x 155x 90	900 mm	130,14 €



INOX



BASE LINEAR P / AZULEJO 360° INOX

Código	Medida caixa	Grelha	und
20501IA300	380 x 155 x 90	300 mm	75,65 €
20501IA500	580 x 155 x 90	500 mm	93,82 €
20501IA600	680 x 155 x 90	600 mm	99,86 €
20501IA800	880 x 155 x 90	800 mm	112,41 €
20501IA900	900 x 155 x 90	900 mm	130,14 €

Saída 40 / 50 mm
Altura 70 mm



BASE LINEAR P / AZULEJO 360° OURO MATE

Código	Medida caixa	Grelha	und
20501OA600	680 x 155 x 90	600 mm	148,23 €



Saída 40 / 50 mm
Altura 70 mm

BASE LINEAR P / AZULEJO 360° PRETO

Código	Medida caixa	Grelha	und
20501PA600	680 x 155 x 90	600 mm	131,76 €

Saída 40 / 50 mm
Altura 70 mm

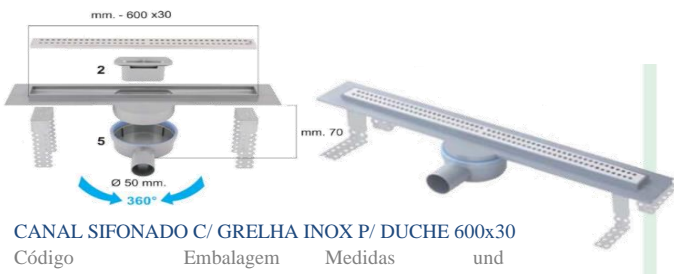

CANAL SIFONADO C/ GRELHA INOX P/ DUCHE 600x30

Código	Embalagem	Medidas	und
20501I60030	2	600x300	114,69 €

Altura 70 mm



VALVULA REBAIXADA EXTRA PLANA

Código	Embalagem	Medidas	und
20501AB115	10	115	15,25 €

TAMPOS SANITA LACADOS MDF



TAMPO LACADO MDF UNIVERSAL

Código	Embalagem	Desig.	und
1600403	1	Lacado	42,70 €

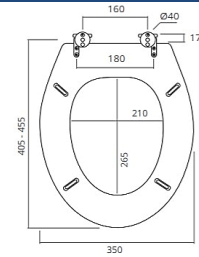

TAMPO LACADO MDF MUNIQUE

Código	Embalagem	Desig.	und
1600409	1	Lacado	42,70 €

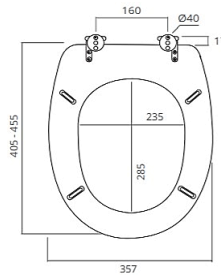

TAMPO LACADO MDF ALFA

Código	Embalagem	Desig.	und
1600404	1	Lacado	42,70 €

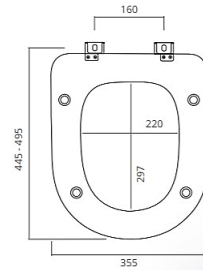

TAMPO LACADO MDF CONCORDE

Código	Embalagem	Desig.	und
1600408	1	Lacado	42,70 €

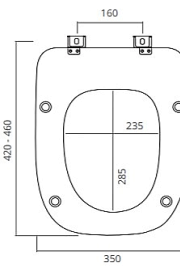

TAMPO LACADO MDF REGINA

Código	Embalagem	Desig.	und
1600412	1	Lacado	42,70 €

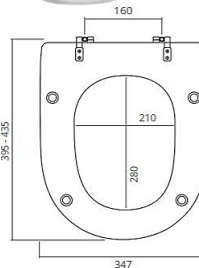

TAMPO LACADO MDF MADALENA

Código	Embalagem	Desig.	und
1600406	1	Lacado	42,70 €

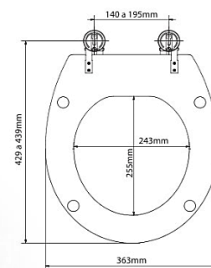

TAMPOS SANITA LACADOS MDF

TAMPOS SANITA LACADOS MDF



TAMPO LACADO MDF VENEZA

Código	Embalagem	Desig.	und
1600405	1	Lacado	42,70 €

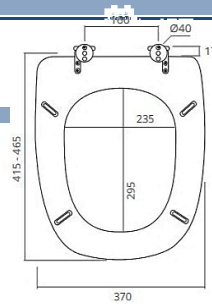

TAMPO LACADO MDF APOLO

Código	Embalagem	Desig.	und
1600407	1	Lacado	42,70 €

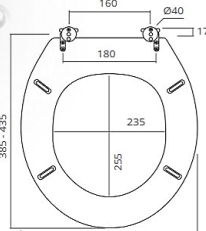

TAMPOS SANITA TERMODURO

GALA PLUS 155 TERMODURO

Código	Embalagem	Desig.	und
16004TER155	5		41,18 €

Alfa-Dama-Danuvio-Estoril-Prestige
Forença-Meridian-Nexo-Regina-Renasçaça-

Tampa com aba

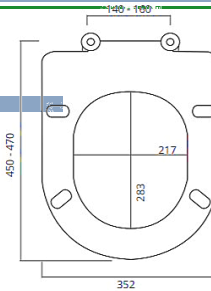

GALA PRESTIGE 955 TERMODURO

Código	Embalagem	Desig.	und
16004TER955	5		41,18 €

Alfa-Dama-Danuvio-Estoril-Prestige
Forença-Meridian-Nexo-Regina-Renasçaça-

Tampa sem aba

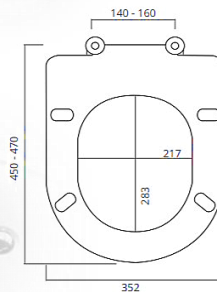

MUNIQUE 157 TERMODURO

Código	Embalagem	Desig.	und
16004TER157	5		41,18 €

Madalena-Europa-Apolo-M.Rosa-Munique-Munique Plus
Zoom-Vitoria-Italia-Lisboa-Italia-Lunar

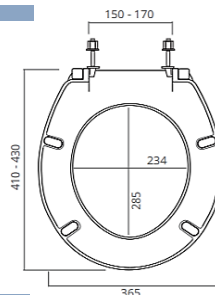

REFLEX TERMODURO

Código	Embalagem	Desig.	und
16004TER609	5		46,06 €

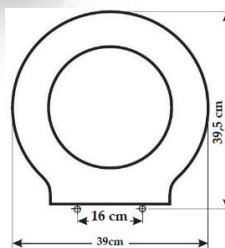

TAMPOS SANITA TERMODURO



PP ALGARVE

Código	Embalagem	Desig.	und
160045B	15	Branco	16,78 €
16004P5B	2	Parafusos und	*

Monte Rosa-Madalena-Europa-Apolo-Estaco-Lunar-Italia

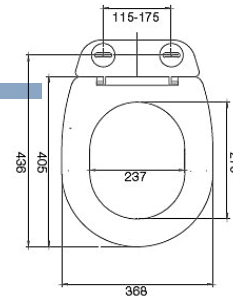

EUROPA

Código	Embalagem	Desig.	und
1600410	6	Branco	10,52 €
1600421	2	Parafusos par	3,36 €

Monte Rosa, Madalena, Munique, Apolo, Vitoria, Lisboa

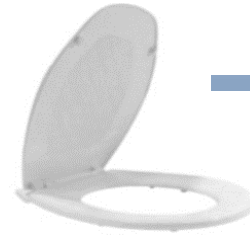
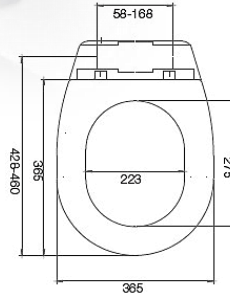

SANI 35 UNIVERSAL

Código	Embalagem	Desig.	und
16004SAN35	15	Branco	13,00 €
16004P35		Parafusos	4,76 €

Munique - Vitória - Zoom



GALIZA

Código	Embalagem	Desig.	und
1600415	1	Branco	12,81 €

Alfa, Estoril, Regina, Condor, Prestige, Meridian

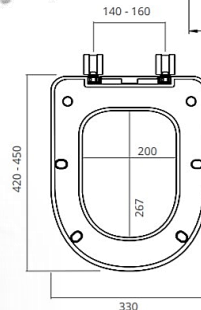

CONCORDE

Código	Embalagem	Desig.	und
1600416	1	Branco	22,81 €

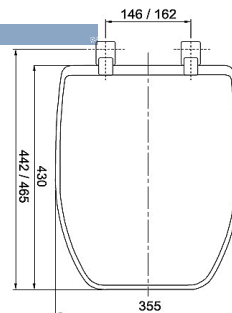

TAMPOS SANITA EM PP



APOLO EUROPA C/ PALA ESTREITA

Código	Embalagem	Desig.	und
1600417	6	Branco	16,68 €

Monte Rosa, Madalena, Munique, Polo, Apolo, Vitoria, Lisboa
Madalena, Zoom, Algarve e Lisboa.

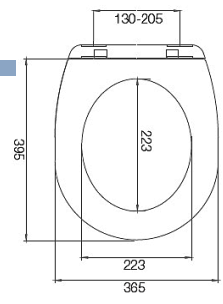

SANI 20 POP

Código	Embalagem	Desig.	und
16004SAN20	5	Branco	19,63 €

Sanitana Pop



Economico

Código	Embalagem	Desig.	und
1600401	6	Branco	9,85 €
1600420	2	Parafusos un	0,91 €



TAMPOS SANITA EM PP

QUARZO 2020
 Código 1600455Q Embalagem 5 Desig. Branco 75,35 €

ONIX PLUS 2 EM 1 (Aplicação Mochila)
 Código 1600481 Embalagem 5 Desig. Branco 95,16 €
 16004662 Saco acessórios Monobloco 11,72 €

TIPO OLI POP
 Código 16004653 Embalagem 5 Desig. Branco 43,99 €

TURCHESE
 Código 1600449 Embalagem 5 Desig. Branco 71,76 €
 16004641 1 Tubo descarga 50,85 €

ZAFFIRO MONOBLOCO 2426 INFERIOR
 Código 1600470 Embalagem 5 Cor Branco 120,12 €



AUTOCLISMOS EXTERIORES

AUTOCLISMOS EXTERIORES

Mecanismos



PUSH ECO

ECO TIRETTE

ATLAS CABOS

VÁLVULAS DESCARGA

Código	Embalagem	Modelo	
1600457	25	Push Eco	29,23 €
1600467	25	Eco Tirette	30,15 €
1600465	25	Atlas Cabos	38,92 €



UNI PLAST

TORNEIRA DE BOIA

Código	Embalagem	Modelo	
1600458	25	Uniplast 3/8	25,33 €
1600459	20	Uni F 3/8	28,57 €



UNI BOTTOM

IVC100 PLUS

TORNEIRA DE BOIA

Código	Embalagem	Modelo	
1600460	25	Unibottom 3/8	17,92 €
1600468	25	Unibottom 1/2	29,34 €
16004936	25	IVC 100	28,57 €



ESTRUTURAS

Código	Embalagem	Modelo	
CR01000038869	1	SIMFLEX 80	189,00 €

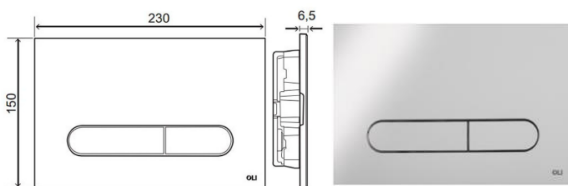

PLC BOUND CROMO OLI 74 / 80

Código	Embalagem	Modelo	
CR01000038869	1	CROMO	115,56 €

PLACA DE COMANDO

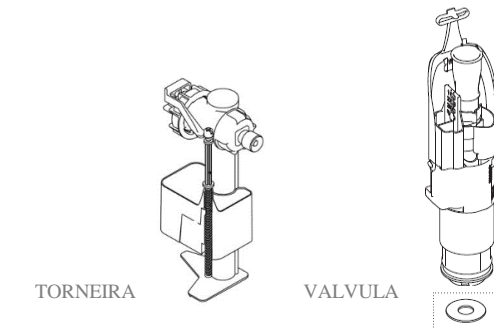

ACESSÓRIOS PARA ESTUTURA

Código	Modelo	Modelo	
160045774	VALVULA	OLI 74 / 80	44,80 €
160046074	TORNEIRA	OLI 74	25,33 €

ACESSÓRIOS DE AUTOCLISMO

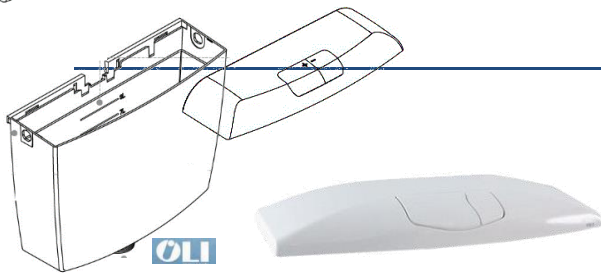

TAMPA COMPLETA AUTOCLISMO

Código	Embalagem	Modelo	
1600461	10	Quarzo	29,20 €



TUBO DESCARGA

Código	Embalagem	Medida	
1600452BM	10	32/50 x 325	5,27 €
1600453BM	10	40/50 x 350	4,67 €



EMBOQUE SANITA

Código	Embalagem	Modelo	
1600430	10	Pequeno	1,97 €
1600431	10	Grande	1,97 €
1600432	50	Tipo jas	2,24 €



BOIA VEDAÇÃO SANIATO

Código	Embalagem	Des.	
16004SAN154	10	Sem tubo	4,12 €
16004SAN153		Com tubo	3,05 €



EMBOQUE SANITA INTERIOR

Código	Embalagem	Medida	
1600433	10	40	1,18 €
1600434	10	32	1,18 €



SACO ACESSÓRIOS PARA AUTOCLISMO

Código	Modelo	
1600466	2010	7,02 €



VEDANTE CONICO P/ TUBO DESCARGA

Código	Embalagem	
1600469	10	3,98 €



CONJUNTO BOTÃO POUSSOIR ECO

Código	Embalagem	
1600457B	10	11,72 €



VEDANTE P/ VALVULA DESCARGA

Código	Embalagem	Modelo	€ Embalagem
1600463	5	60x23.8x2.7	10,78 €
16004753	10	Giada	33,17 €



CONJUNTO 5 ANILHAS ESPONJA 110x68x15

Código	Embalagem	Medida	
1600493	5	110-68-15mm	27,31 €



CANHÃO SANITA

Código	Embalagem	Modelo	
1600206	48	Direito	3,54 €
1600205	48	Excêntrico	3,54 €



LIGAÇÃO SANITA

Código	Embalagem	Modelo	
1600202	36	Direito	4,00 €
1600201	36	Excêntrico	4,29 €

90j+ú«



CANHÃO SANITA 40MM

Código	Embalagem	Modelo	
1600204	36	Excêntrico	3,39 €



TUBO FLEXIVEL PARA SANITA 450 - 240

Código	Embalagem	Medida	
1600101	15	240-450	10,13 €

**LATERAL
E
INFERIOR**



TORNEIRA BOIA 3/8 LATERAL/INFERIOR IDERT

Código	Embalagem	Modelo	
16004937	20	Universal	16,50 €



CANHÃO SANITA BRANCO EXT. C/ CURVA 450/265

Código	Embalagem	Medida	
1600207	15	240-450	10,74 €



BREDA

Código	Embalagem	Desig.	
1600472	5	Branco	32,33 €

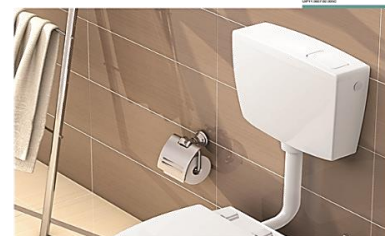

NARA

Código	Embalagem	Desig.	
1600473	5	Branco	50,39 €



ACESSÓRIOS CASA DE BANHO